

Cooker hob - Modular Induction Plate

Induction Hobs

Code: 7361 270

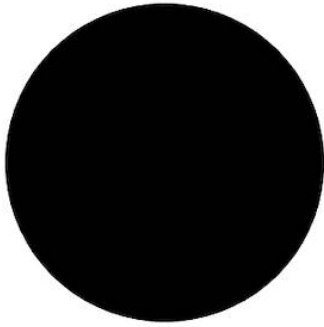

DETAILS

Coloring Black

Edge/Installation Type Flush-mount | Top-mount

Material Ceramic glass

Supply Single-phase: 230 V; 1P + N; Two-phase 400 V; 2P + N; 50.60 Hz

Dimensions \varnothing 270 mm

Full description Induction plate \varnothing 270 mm - black - for Modular Induction system

Heating element single zone

Total power 1.100 (1.400)* W

Power settings 9 power settings per zone + Powerboost

Safety

Safety equipment

Type

Induction Hob

Type of commands

Touch Control

Notes:

* Powerboost

Notes:

TECHNICAL DATA

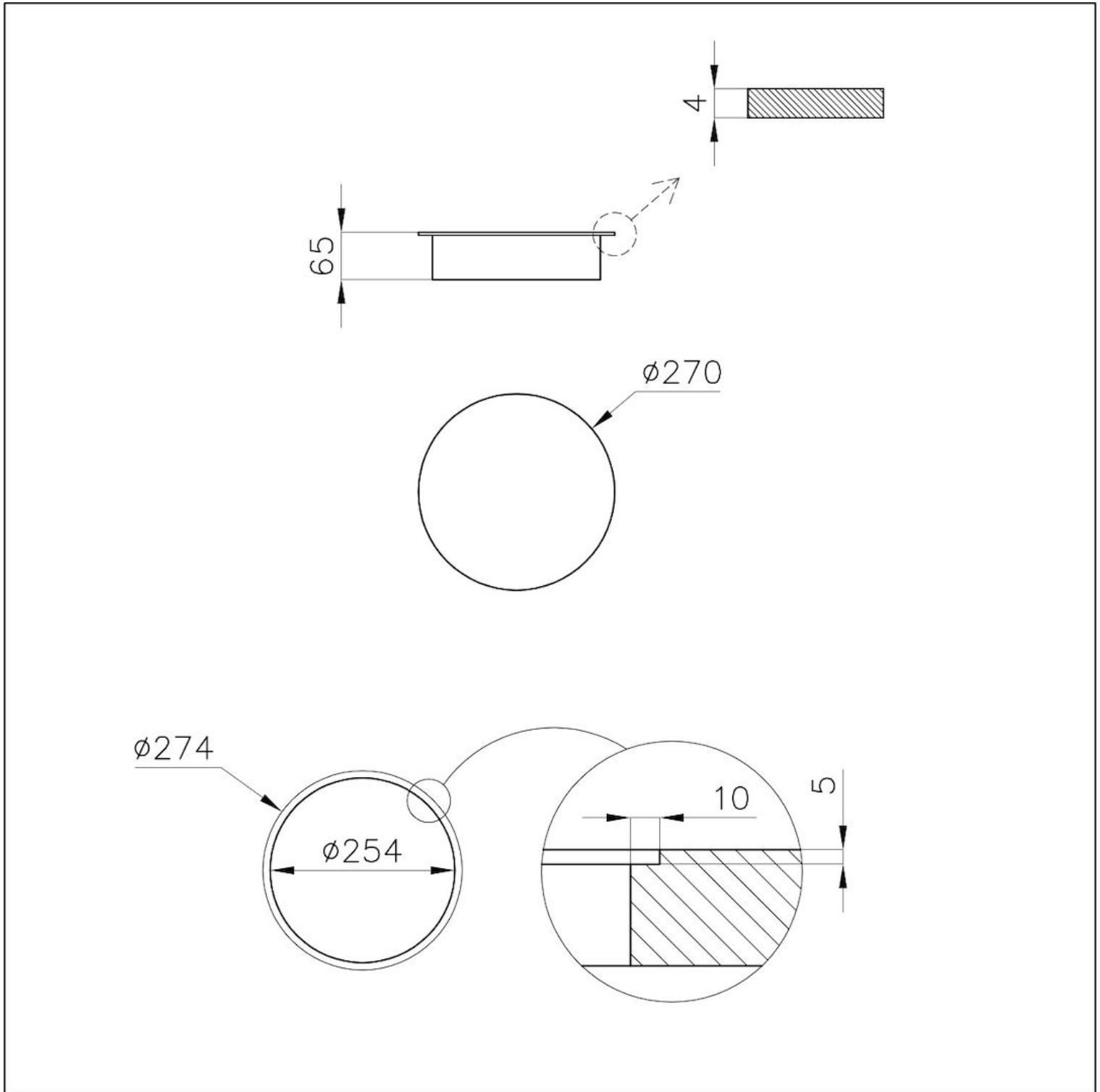

GALLERY



RECOMMENDED PAIRINGS



Cooker hob Touch Control Modular Induction
7368 040

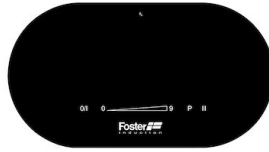

Cooker hob Touch Control Modular Induction
7368 030



Cooker hob Touch Control Modular Induction
7368 020



Modular Induction - Connection Box
7369 040



Modular Induction - Connection Box
7369 030



Modular Induction - Connection Box
7369 020